

Users manual

Gas wall hung Boiler condensing Buderus 500-24S

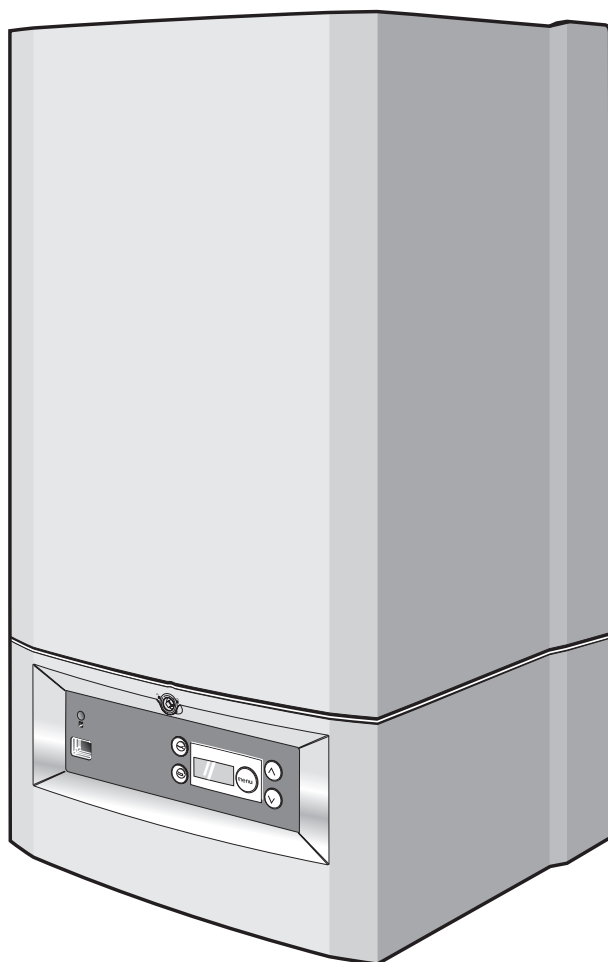

Buderus

Introduction

Please read these instructions and follow them carefully for a safe and economical use of your system boiler.

Important general instructions for use

This device should only be used for its intended purpose and in accordance with the regulations.

It is a requirement and in your own interest, and that of safety that this boiler must be installed by a CORGI registered installer, in accordance with the relevant requirements of the current Gas Safety (Installation and Use) Regulations, The Building Regulations, current I.E.E. Wiring Regulations and the relevant British Standard Codes of Practise.

The device may only be used in combination with the units, accessories and spare parts listed in the installation and maintenance instructions.

Other combinations of units, accessories and consumables are only to be used if they completely fulfil the specifications involved, and if system performance and safety are not affected in any way.

Subject to technical modifications

Constant development efforts may result in minor differences between illustrations, functional steps and technical data.

Cleaning

For normal cleaning simply dust with a dry cloth. To remove stubborn marks and stains, wipe with a damp cloth and soap and finish off with a dry cloth.

DO NOT use abrasive cleaning materials.

Gas Council Appliance No. :

Buderus 500-24S : 41-110-24

Contents

1	Safety precautions	4
2	Installation area / boiler room	4
3	Working in the heating system	4
4	Functions of the system and operating instructions	4
5	Maintenance intervals	4
6	Conversion to LPG	4
7	Abbreviations	4
8	Permanent clearances	5
9	DBA	6
10	Initial start-up	7
10.1	Preparing the boiler for operation	7
10.2	Operational and fault codes	9
11	Taking the system out of service	10
11.1	Draining the system in case of frost	10

Preface

Dear Customer,

Your Buderus **500 Series** wall-mounted condensing gas system boiler has been designed and built in accordance with state-of-the-art technological standards and the recognised safety rules. Special focus has been placed on operator convenience in this respect.

Carefully read the safety instructions and operating manual to ensure safe, economic and ecologically beneficial use of the unit.

Due to the high efficiency of the boiler a plume of water vapour may form at the terminal during operation. This is normal.

1 Safety precautions

IF YOU SMELL GAS:

DO NOT SMOKE OR STRIKE MATCHES
DO NOT TURN ELECTRICAL SWITCHES ON OR OFF

PUT OUT NAKED FLAMES
OPEN DOORS AND WINDOWS
KEEP PEOPLE AWAY FROM AFFECTED AREA
TURN OFF THE CONTROL VALVE AT THE GAS METER
CALL THE NATIONAL GAS EMERGENCY SERVICES,
FREE ON: 0800 111 999



NOTE

In the event of any other type of incident, shut off the main gas supply and electric supply to the appliance and seek assistance from a CORGI registered engineer.

2 Installation area / boiler room



DANGER!

The air intake and outlet openings must not be reduced in size or closed.



DANGER!

Do not store or use inflammable materials or liquids near the heating boiler.



NOTE

To prevent the boiler from being damaged, care must be taken not to contaminate the combustion air with halogenated hydrocarbons (e. g. contained in aerosol sprays, solvents, detergents, paints, and adhesives), or with high quantities of dust. The room in which the boiler is installed must be frost-proof and be well ventilated.

3 Working in the heating system



DANGER!

Only a CORGI registered Engineer is to be entrusted with the installation of this boiler, the gas supply and the flue connection. Commissioning, Servicing and any Repairs must be carried out by a competent person i.e.:

a CORGI Registered Engineer.

All CORGI Registered Installers carry a CORGI identification card and have a registration number. Both should be recorded in your boiler logbook. You can check if your installer/Engineer is registered by telephoning 01256 372300 or by writing to:

CORGI, 1 Elmwood, Chineham Business Park, Crockford Lane, Basingstoke. RG24 8WG.



NOTE

The heating boiler is designed exclusively for heating water as part of a central heating system and/or hot-water system.

It is recommended to enter into a service contract with a specialist company.

4 Functions of the system and operating instructions

The installer should familiarize the user with the functions and operation of the heating system and ensure that a complete set of technical documentation is supplied.

5 Maintenance intervals

For optimum, long-term reliable functioning of the heating boiler, and in order to be able to claim under the terms of the manufacturer's warranty, the heating boiler must be inspected and maintained at least once a year (under normal operating conditions) by an officially recognized installation and service engineer. The term "normal operating conditions" means that the heating boiler is used to provide central heating and/or hot water to no more than one single-family dwelling.

In all other cases, the heating boiler must be inspected and maintained by an officially recognised installation service engineer every 2,500 burner operating hours.

6 Conversion to LPG

The boiler is suited for natural gas. To convert the boiler to LPG you must contact a CORGI registered fitter.

7 Abbreviations

DBA = Control unit (Dedicated Burner Automat)

MCW inlet = Mains Cold Water inlet

CH flow = Central Heating flow

CH return = Central Heating return.

8 Permanent clearances

The boiler must be located in an area with the following permanent clearances.

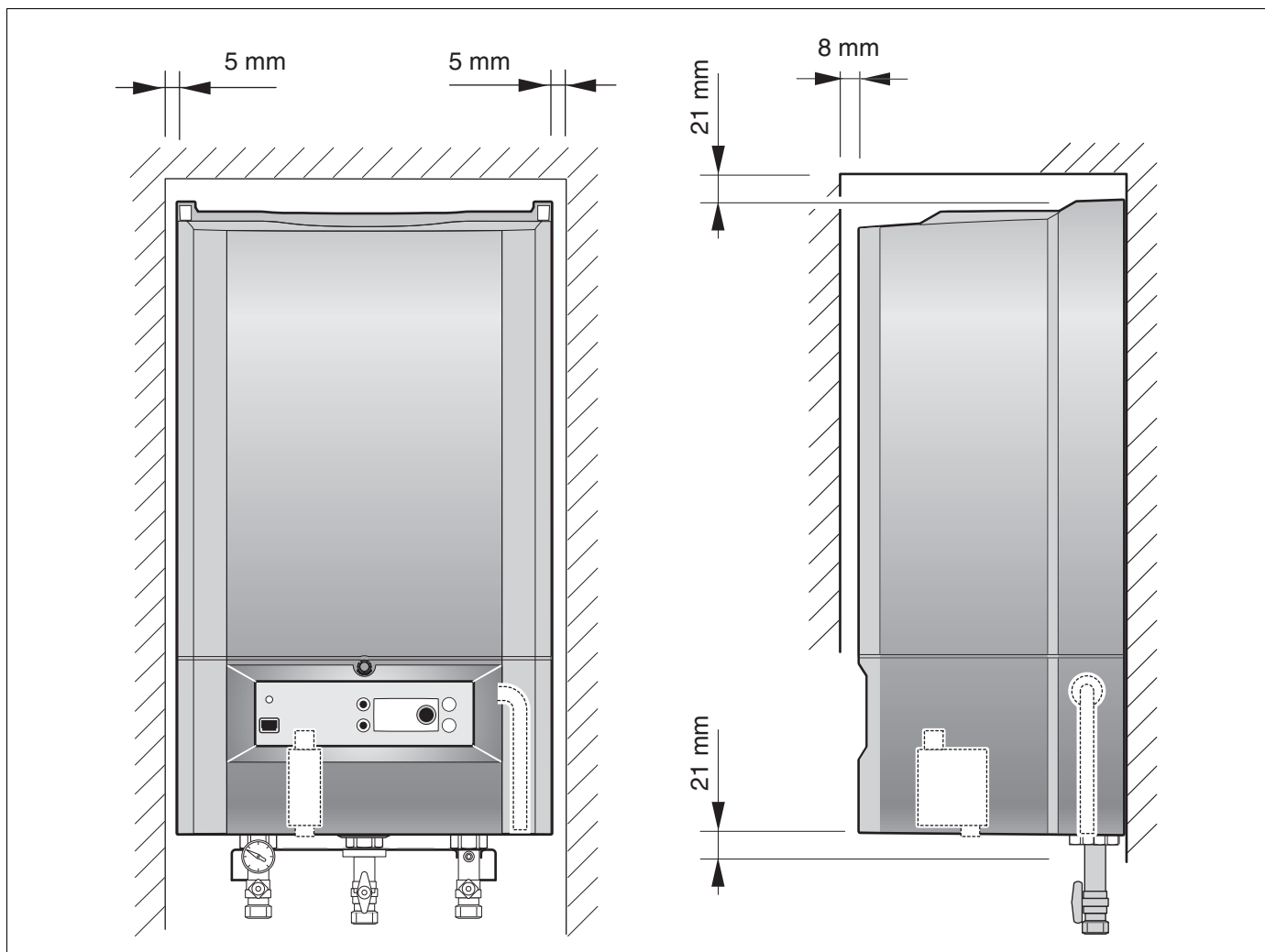

NOTE

The permanent clearances do not change if a wall-spacing frame is used.

The installer or service engineer must be able to create sufficient service clearances. These clearances should have been considered at time of installation.

9 DBA

The boiler is equipped with a boiler control unit (DBA). This is the internal control of the boiler. The DBA is located behind the access panel.

The DBA allows you to operate the boiler and to make adjustments in its settings.

DBA overview:

1. Mains switch (see fig. 1)

Use this switch to turn the boiler on or off.

2. Reset button (see fig. 1)

When a blinking code is in the display, it is possible to try and restart the boiler by pressing this button.



NOTE

It is not possible to reset the boiler when there is no fault code blinking in the display.

3. Service Button (see fig. 1)

Is used for servicing purposes only.

DO NOT use this button!

4. Display (see fig. 1)

Setting, adjustments and fault codes are displayed on the DBA (see fig. 2).

5. Menu button (see fig. 1)

The menu button  allows you to scroll through the menu items.

Press the  button once to display the current DHW temperature setting (in combination with an external hot water cylinder).

Press the  button twice to display the current setting of summer operation.

Press the  button three times to display the current CH flow temperature setting.

6. and 7. Up and Down keys (see fig. 1)

These keys can be used for adjusting temperatures and activating or de-activating certain summer operation.

The  key, when pressed, gives the current operating status of the boiler.

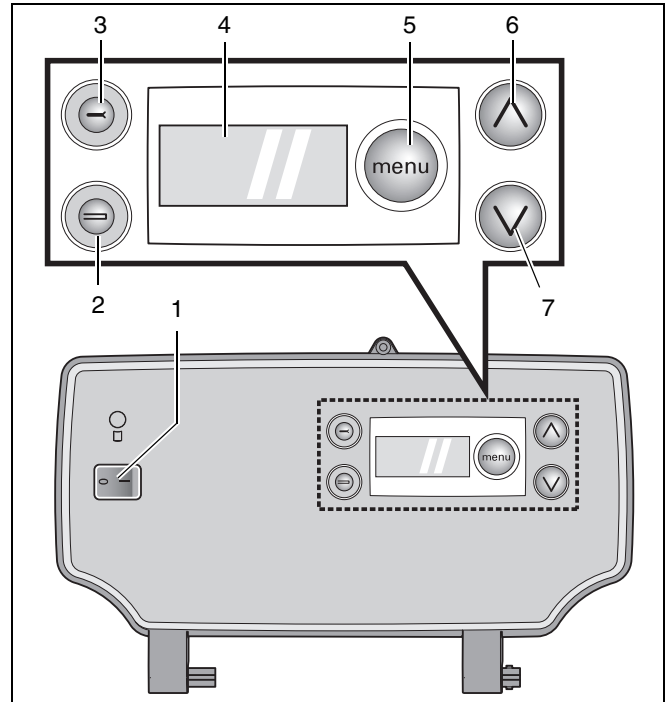

fig. 1 DBA

item 1: mains switch

item 2: "reset" button

item 3: "service" button

item 4: display

item 5: "menu" button

item 6: adjusting arrow up

item 7: adjusting arrow down

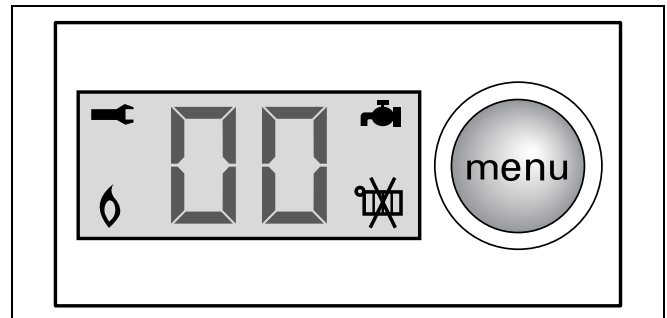

fig. 2 DBA display

10 Initial start-up

10.1 Preparing the boiler for operation

Please also note the user manual supplied with the external time controls and thermostat.

10.1.1 Check water pressure

- Check the pressure gauge (fig. 3, item 3) located at the bottom of the boiler for the current system pressure. Optimum system pressure is 1.5 bar.

10.1.2 Fill the heating system



WARNING!

The wall-mounted condensing gas system boiler must not be activated at this stage.

The system should be filled with untreated mains water.

- Turn off the boiler by pressing the mains switch to "0" (fig. 4, item 1).
- If necessary open the CH flow and CH return servicing valves (fig. 3, item 1 and 2).

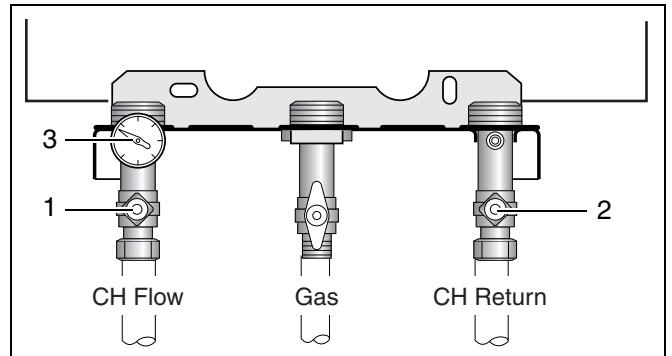

fig. 3 Servicing shut off valves

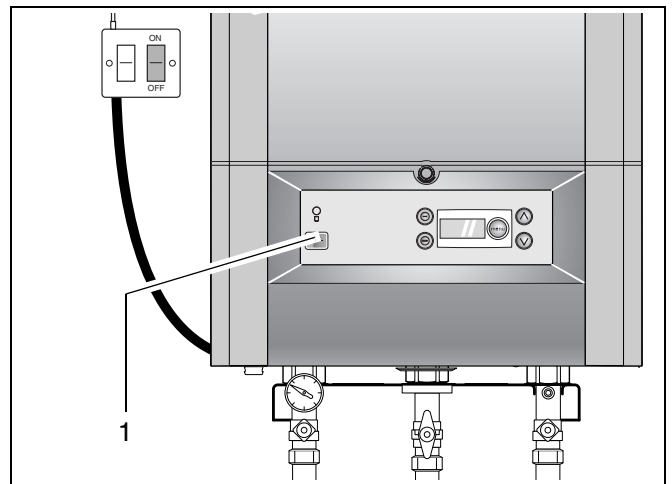

fig. 4 DBA – Mains switch

- Connect filling loop (fig. 5).
- Open both stop valves (fig. 5).
- Fill the system to a pressure of approx. 1.5 bar (fig. 3, item 3).
- Close both stop valves.
- Vent the air from all radiators starting with the lowest radiator and working up to the highest point.
- Check the pressure after venting. If the pressure has dropped under 1.0 bar then top up the system as described previously.
- Disconnect the filling loop and cap off.

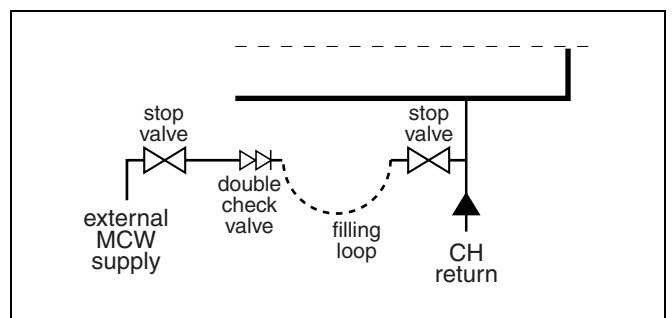

fig. 5 Connecting filling loop





NOTE

If there are frequent water losses, have the system examined and repaired by a CORGI registered installer. Have the inhibitor concentration checked every year.



10.1.3 Temperature-setting adjustments



Setting the domestic hot water (DHW) temperature (in combination with an external hot water cylinder)

- Press  button (see fig. 6, item 2) once then adjust the DHW temperature to the desired temperature (40 °C - 60 °C) using the  and  keys (see fig. 6, item 1). Factory setting is 48 °C.

Setting the boiler to summer operation

When you want to make sure that your boiler will not operate for central heating in the summer then you can set the boiler to summer operation. The boiler will then only operate for DHW (in combination with an external hot water cylinder).

- Press the  button (see fig. 6, item 2) twice. The current setting blinks.
- Use the  and  keys to adjust to desired setting.

	Central heating is on
	Central heating is off (summer operation). DHW is still available (in combination with an external hot water cylinder).



NOTE



When summer operation is active then the boiler will not operate for central heating until summer operation has been deactivated.

Setting the flow temperature for CH



NOTE

It is not possible to set the flow temperature when the boiler is set to summer operation.

- Press  button (see fig. 6, item 2) three times then adjust the flow temperature to the desired temperature (30 °C – 80 °C) using the  and  keys (see fig. 6, item 1). Factory setting is 80 °C.

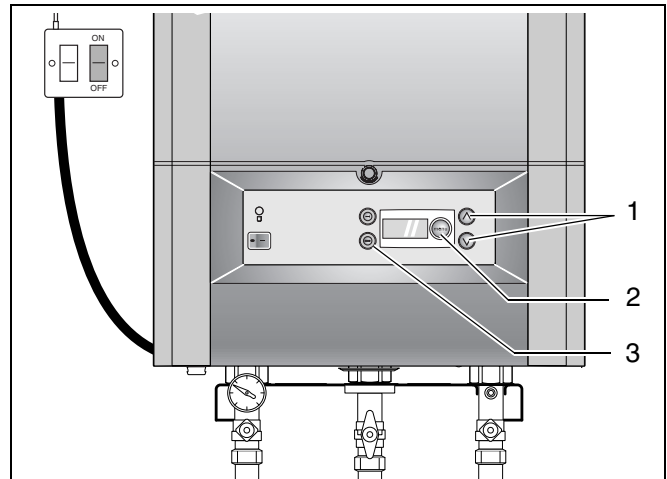



fig. 6 DBA – adjustment arrows

10.2 Operational and fault codes

Operating conditions and possible faults can be seen, pressing the  key.

All codes not contained in table 1 should be noted down separately. These are malfunctions that require the presence of a CORGI installer.

Display after pressing service button	Meaning	Rectification
0A, 0C, 0E, 0H, 0L, 0U, 0Y	Boiler is ready for operation	
6R	Burner not ignited	Press Reset button  (fig. 6, item 3). If the burner fails to ignite after several unblocking operations, consult a CORGI installer.
-H	Normal heating mode	Maximum comfort when set at 60 °C
=H	Normal hot water mode	

table 1 Operational and fault codes

11 Taking the system out of service

- Turn off the boiler by pressing the mains switch to "0" (fig. 4, item 1).
- Close the gas service valve by turning it clockwise (fig. 7, item 1).

Frost protection

The boiler has an automatic frost protection. When the CH flow temperature drops below 7 °C then the boiler will start up.

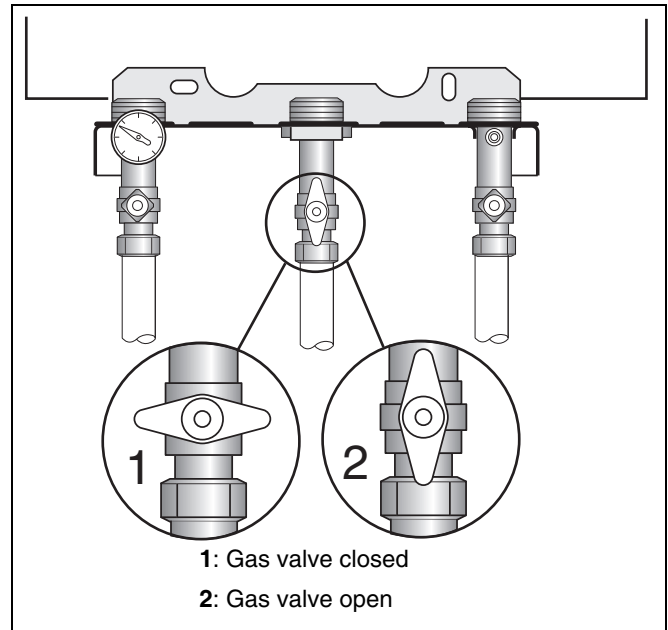

fig. 7 Gas service valve

11.1 Draining the system in case of frost

It is not recommended, but if the boiler needs to be shut down for a longer period of time, then it is necessary to drain the system. Especially when there is a chance for frost conditions.

- Turn off the boiler by pressing the mains switch to "0" (fig. 4, item 1).
- Close the gas shut off valve (fig. 7, item 1).
- Drain the system at its lowest point using the stop valves or radiator (see fig. 8). The automatic air vent at the system's highest point must be open.

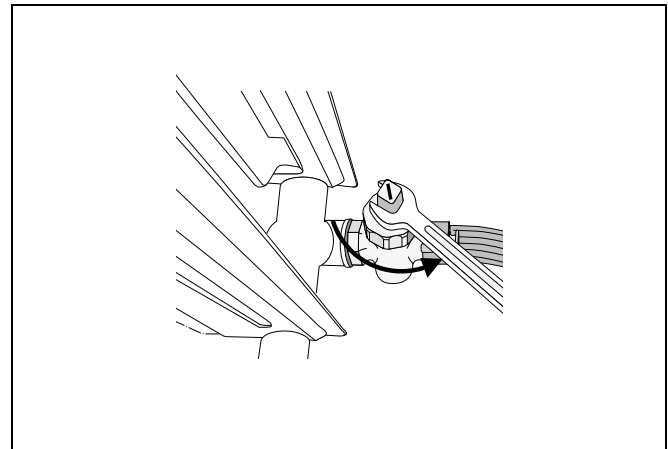

fig. 8 Draining the system

Buderus

Heating system specialist:

Buderus
Cotswold Way
Warndon
Worcester
WR4 9SW
Telephone: 01905 - 752 936
Fax: 01905 - 753 130

Customer Services:	Tel: 0870 - 421 5933	
Technical Product Support:	Tel: 0870 - 421 5944	
Sales:	Tel: 01905 - 752 640	Fax: 01905 - 456 445 / 455 394
Returns:	Tel: 01905 - 752 531	Fax: 01905 - 455 392
Spares:	Tel: 01905 - 752 576	Fax: 01905 - 754 620

www.buderus.co.uk

Buderus is a trading name of BBT Thermotechnology UK Ltd.