

# Operating instructions

## RC20 room controller

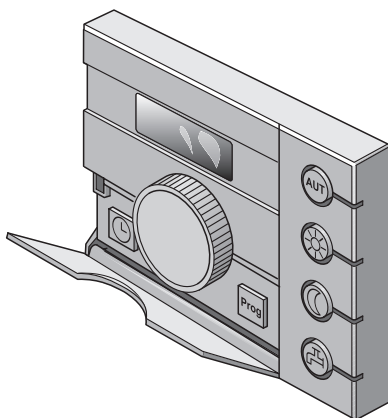

Buddeus

<b>1</b>	<b>Introduction</b> . . . . .	<b>3</b>
<b>2</b>	<b>Safe handling of your RC20</b> . . . . .	<b>4</b>
	2.1 Correct use. . . . .	4
	2.2 Please observe these notes. . . . .	4
	2.3 Cleaning . . . . .	5
	2.4 Disposal . . . . .	5
	2.5 Other notes. . . . .	5
<b>3</b>	<b>First steps with your room controller</b> . . . . .	<b>6</b>
	3.1 Controls. . . . .	6
	3.2 Quick reference guide . . . . .	9
<b>4</b>	<b>The functions</b> . . . . .	<b>10</b>
	4.1 Changing the room temperature directly. . . . .	10
	4.2 Setting the room temperature . . . . .	14
	4.3 Heating domestic hot water. . . . .	17
	4.4 Setting day and time . . . . .	19
	4.5 What is a heating program? . . . . .	20
	4.6 Heating program selection . . . . .	21
	4.7 Heating program summary . . . . .	22
<b>5</b>	<b>Information on setting the programming unit</b> . . . . .	<b>23</b>
	5.1 What does the RC20 room controller regulate?. . . . .	23
	5.2 Control modes for the heating control unit . . . . .	24
	5.3 Tips on energy-efficient heating . . . . .	26
<b>6</b>	<b>Troubleshooting</b> . . . . .	<b>27</b>
	6.1 Frequently asked questions . . . . .	27
	6.2 Fault displays . . . . .	28
	6.3 Resetting faults (reset). . . . .	30
<b>7</b>	<b>Index</b> . . . . .	<b>31</b>

# 1 Introduction

The RC20 room controller makes it easy to operate your Buderus heating system with Energy Management System (EMS). The heating system is controlled in such a way that you benefit from optimum heating comfort and minimum energy consumption.

The RC20 room controller is factory-set for immediate use. You can modify these settings, such as the heating program for example, and match them to your requirements.

Special functions help you to save energy, without sacrificing your personal comfort. For example, simply pressing a key starts domestic hot water heating.



The design and operation of this product conforms to European Directives and the supplementary national requirements. Its conformity is demonstrated by the CE Declaration of Conformity. You can view the Declaration of Conformity on the Internet at [www.buderus.de/konfo](http://www.buderus.de/konfo) or request a copy from your local Buderus office.

## 2 Safe handling of your RC20

The RC20 room controller has been developed and built in accordance with currently recognised standards and safety requirements. However, dangers or material losses may arise if it is used improperly.

- You should therefore only operate the heating system as intended and when it is in perfect working order.
- Please read these instructions carefully.
- Always observe the safety instructions to prevent injury and material losses.

### 2.1 Correct use

The RC20 room controller may only be used to operate and control Buderus heating systems in houses or apartments.

The boiler must be equipped with EMS (energy management system) or UBA1.x (universal burner control). We recommend that the heating system is always operated using the room controller (only emergency operation possible without room controller).

### 2.2 Please observe these notes



#### USER NOTE

- In an emergency isolate the heating system from the mains supply using the emergency stop switch outside the boiler room or by removing the main fuse.
- Call in your local heating contractor to remedy any faults in your heating system immediately.



**CAUTION!**

**SYSTEM DAMAGE**

through frost.

The heating system can freeze up in cold weather if it has been switched off.

- Leave the heating system switched ON constantly.
- In case of fault shutdown, try to remedy the fault by resetting or notify your heating contractor.

## 2.3 Cleaning

- The room controller should only be cleaned with a damp cloth.

## 2.4 Disposal

- Dispose of packaging in an environmentally responsible manner.
- Dispose of old components in an environmentally responsible manner through an approved organisation.

## 2.5 Other notes

Assembly, maintenance and repairs, as well as fault diagnosis, may only be carried out by a heating contractor.



**USER NOTE**

All modifications and settings made on the room controller must consider the implications for the heating system.

Never open the housing of the programming unit.

## 3 First steps with your room controller

### 3.1 Controls

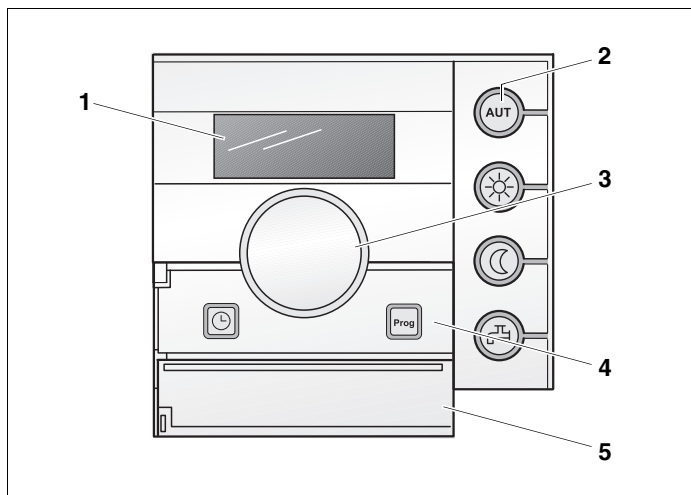

Fig. 1 RC20 controls

**Item 1:** Display

**Item 2:** Keys for basic functions with LEDs

**Item 3:** Rotary selector for changing values and temperatures or for navigating through the menus

**Item 4:** "Prog" and "Time" keys

**Item 5:** Flap; covers the "Prog" and "Time" keys

#### Keys for basic functions (Fig. 1, Item 2)

 "AUT" key (automatic)

 "Day mode" key

 "Night mode" key

 "DHW" key

#### Keys for extended functions (Fig. 1, Item 4)

 "Time" key

 "Prog" key (program)

## Display (Fig. 1, Item 1)

The display shows set and actual values and temperature, e.g. the actual room temperature (standard display in factory setting).

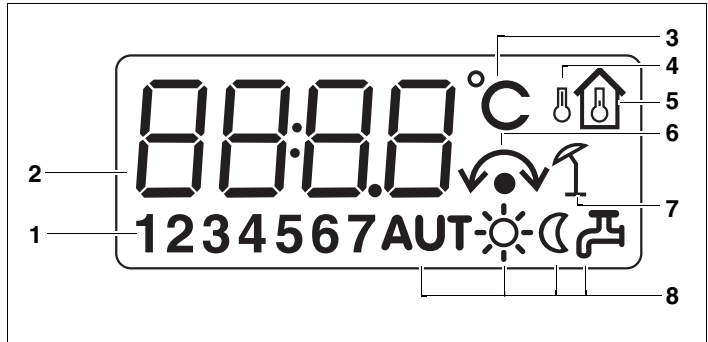
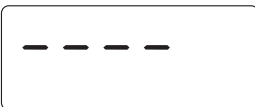

Fig. 2 Explanation of the display elements









- Item 1:** Day (1 = Mo, 2 = Tu,... 7 = Su)
- Item 2:** Set or actual value or temperature
- Item 3:** "Temperature in °C" display
- Item 4:** "Outdoor temperature" display (only in conjunction with a programming unit, for example RC30/RC35, see page 23, RC20 as remote control)
- Item 5:** "Actual room temperature" display
- Item 6:** Display:
  - a) Room temperature can now be adjusted or
  - b) Room temperature has temporarily changed (temporary room setting, see section 4.2.2, page 15)
- Item 7:** "Summer mode" display (only in conjunction with a programming unit, e.g. RC30/RC35, that provides a summer mode for the heating system)
- Item 8:** Operating status symbols (see Tab. 1, page 8)



The display shows four dashes if you try to change a value that cannot be modified or if no setting is possible.

## LEDs (Fig. 1, Item 2, page 6)

The green LEDs and the symbols in the display provide information about the current operating status:

LED	Symbol	Operating status
	<b>AUT</b> "Automatic mode"	The symbol lights up when automatic mode (heating program) is active. The "Day mode" or "Night mode" symbol is also illuminated. <sup>2)</sup> If the holiday function is active, only the "AUT" symbol is illuminated.
	 "Day mode"	The symbol lights up in normal heating mode (day mode).
	 "Night mode"	The symbol lights up in setback heating mode (night mode).
	 "DHW"	The symbol lights up if the DHW temperature falls below the set value. <sup>1)</sup>
		The symbol is not illuminated if the DHW temperature is within the required temperature range or if there is no DHW heating function installed in the EMS. <sup>1)</sup>
		The symbol flashes when hot water is being heated by the "DHW single charge" function. <sup>1)</sup>
	"Auto/day/night mode"	"Temporary room setting" operating mode Room temperature has temporarily changed (see section 4.2.2, page 15) The changed setting is retained until the heating system changes the operating mode (e.g. to night mode).

Tab. 1 Operating status

<sup>1)</sup> On boilers with UBA 1.x the LED never lights up.

<sup>2)</sup> On boilers with UBA 1.x only one LED lights up.











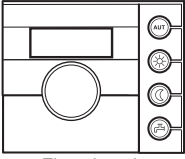



## Flap (Fig. 1, Item 5, page 6)

To open the flap, pull the flap on the recessed grip on the left-hand side towards you. Opening the flap activates a switch. The flap covers the keys for setting the time and the day, as well as the heating program selection.







## 3.2 Quick reference guide

### Setting temperatures (Chapter 4, page 10)

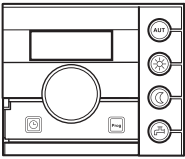
	Keys	Function	Factory setting	Setting		
				Range	System	
 <p>Flap closed</p>	 + 	Temperature for automatic mode (day/night)	21/17 °C	as for day/night		
	 + 	Temperature for day mode (manual mode)	21 °C	6 – 30 °C		
	 + 	Temperature for night mode (manual mode)	17 °C	5 – 29 °C		
		Return to Automatic mode after changing the day or night temperature				
		Change temperature temporarily ("temporary room setting"  )				
	  	Pressing a key cancels the temporary room setting and activates the selected mode.				
	 + 	DHW temperature	60 °C	30 – 60 (80) °C		

### Functions (Chapter 4, page 10)

	Keys	Function	Page
 <p>Flap open</p>	 + 	Set the time	page 19
	 + 	Select a heating program	page 21

## 4 The functions

This chapter describes how to change room and DHW temperatures, the advantages of automatic mode, how to make effective use of manual mode, etc.

The functions are controlled by pressing a key on the right-hand side of the RC20 and turning the rotary selector.

### 4.1 Changing the room temperature directly

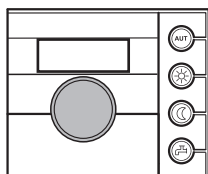

If all of your accommodation is too cold, raise the room temperature using the rotary selector, and leave the thermostatic radiator valves unchanged.

Example: setting the room temperature



Set the required room temperature by turning the rotary selector.



#### USER NOTE

The temporarily changed setting is retained until you press an operating mode key or until the heating system changes the operating mode (e.g. to night mode).

See section 4.2, page 14 for information on other ways of changing the room temperature.

### 4.1.1 Selecting the operating mode

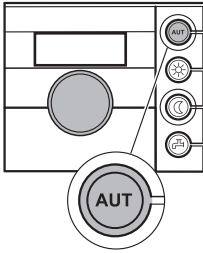

You may operate the RC20 room controller in two ways:

- in automatic mode
- in manual mode

### 4.1.2 Selecting automatic mode

Generally, homes are heated less at night than during the day. The room controller changes over automatically between day mode (standard heating mode) and night mode (setback heating mode). This makes changing the thermostatic radiator valves in the morning and evening superfluous.

The times at which the heating system changes from day to night mode – and vice versa – are factory-set via heating programs (see section 4.5 "What is a heating program?", page 20). However, you can also select a different heating program from the preset standard programs.

The heating program raises or lowers the room temperature at fixed times. The time at which the system changes from night to day mode (and vice versa) is known as the "switching point".

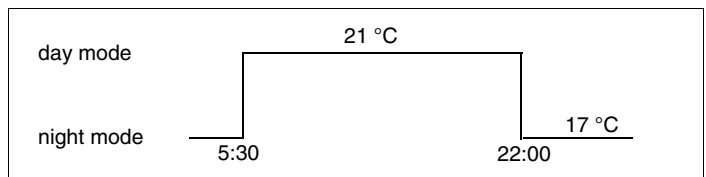

Fig. 3 Changeover between day and night mode at fixed times

Example: activating automatic mode



Press "AUT".



The display shows the "AUT" symbol; automatic mode is active. While the "AUT" key is held down, the arrow symbol lights up and the display shows the set room temperature for automatic mode.



When the "AUT" key is released, the display shows the standard display (e.g. the actual room temperature) again. In addition, either the "Day mode" or "Night mode" symbol is illuminated. This depends on the set times for day and night mode.



### USER NOTE

If the RC20 is installed as a remote control unit (see section 5.1 "What does the RC20 room controller regulate?", page 23): you may find during the in-between seasons of spring and autumn that your home feels too cold, even though the heating system is in summer mode because of the outside temperature (DHW heating only). In this case, choose manual mode to run the heating one hour at a time.

The room temperature will be controlled if the RC20 is the sole programming unit. As the outside temperature is ignored, there can be no summer/winter changeover.

### 4.1.3 Selecting manual mode

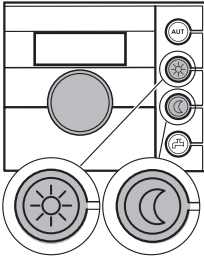

For example, if you want the heating to run for longer in the evening or not quite as early in the morning, you can also select the day and night mode manually. There are two temperatures for manual day and night mode. You can use day mode to run the heating on cool days in summer mode (only if the RC20 is installed as a remote control unit, see section 5.1, page 23).



Press the "Day mode" button to switch to manual mode.



The display will show the set room temperature for day mode. The "Day mode" symbol lights up in the display. Now your heating system is in constant day mode (standard heating mode).



Press the "Night mode" button to switch to manual mode.

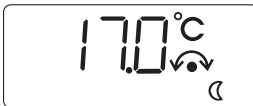

The display will show the set room temperature for night mode. The "Night mode" symbol lights up in the display. Now your heating system is in constant night mode (setback heating mode), and operates at a lower room temperature.



#### USER NOTE

If you have selected manual mode, the selected heating program will no longer be active (for example no night setback of the room temperature).

To return to automatic mode, press "AUT".

## 4.2 Setting the room temperature

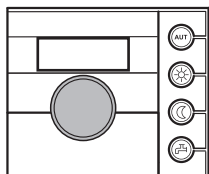

The rotary selector can always be used to adjust the room temperature. The room temperature can be adjusted in three ways:

- Change the room temperature for the current operating mode (e.g. automatic day mode). The changed setting applies to automatic day mode from now on.
- Change the room temperature temporarily. The changed setting is retained until the heating system changes the operating mode (e.g. to night mode).
- Change the room temperature for another operating mode (e.g. change the night room temperature during the day). The changed setting will apply to this operating mode from now on.



### USER NOTE

The actual room temperature is shown as the standard display. Your heating contractor can also set the controller to a different standard display.



### USER NOTE

The room temperature sensor is in the RC20. It is not possible to connect a separate external room temperature sensor.

### 4.2.1 Setting the room temperature for the current operating mode

The set room temperature applies to the currently active heating mode, i.e. day or night mode. The currently active heating mode is indicated by the relevant symbols.

You are currently in automatic mode and would like to change the room temperature.

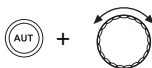

Press the "AUT" key and select the required room temperature using the rotary selector.



The display changes from the standard display to the set room temperature, which you can now alter (e.g. here for automatic day mode). Turning the rotary selector clockwise increases the value, turning anti-clockwise reduces the value.



The newly selected room temperature will be saved after approx. 2 seconds. The display then returns to the standard display (e.g. actual room temperature).

## 4.2.2 Changing the room temperature temporarily (temporary room setting)

You are currently in automatic mode or in manual mode and would like to change the room temperature temporarily. This function is available when the RC20 is the sole programming unit or it has been installed as a remote control unit for an RC35 programming unit (see section 5.1, page 23). If the RC20 has been installed as a remote control unit for an RC30 programming unit, use manual mode (see section 4.1.3, page 13).



### USER NOTE

If holiday mode is active for a heating circuit when using an RC35 (RC20 as remote control), the holiday setting can be adjusted on the RC20, but not the temporary room setting.



Set the required room temperature by turning the rotary selector.



The display changes from the standard display to the set room temperature, which you can now alter. Turning the rotary selector clockwise increases the value, turning anti-clockwise reduces the value.

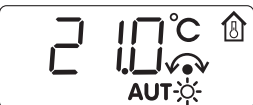

The newly selected room temperature will be saved after approx. 2 seconds. The display then returns to the standard display (e.g. actual room temperature).



## USER NOTE

The symbol  indicates that this is a temporary room setting.

The temporarily changed temperature setting is retained until you press one of the operating mode keys (e.g. "AUT" key) or until the heating system changes the operating mode (e.g. to night mode).

### 4.2.3 Setting the room temperature for an operating mode that is currently inactive

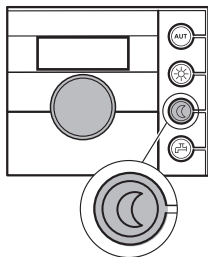

You can also adjust the room temperature for an operating mode that is currently inactive.

For example, you are currently in automatic "Day" mode and would like to alter the night setback temperature.

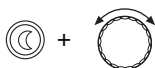

Hold down "Night mode" and select the required room temperature with the rotary selector.

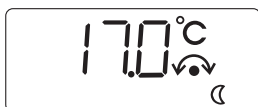

The display changes from the standard display to the set night temperature, which you can now alter.

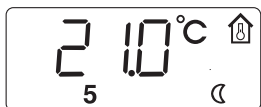

Release the "Night mode" key. The newly selected night temperature will be saved after approx. 2 seconds. The display then reverts to the standard display.



Press "AUT".

The LED in the "AUT" key lights up; automatic mode is active again.



## USER NOTE

If you are currently in automatic "Night mode", and you wish to adjust the set day temperature, proceed as described above, but instead hold down the "Day mode" key.



### 4.3 Heating domestic hot water

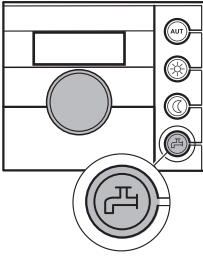

The programming unit also offers you the option of heating DHW in an energy-conscious manner. Adjustment depends on how the room controller was installed (see section 5.1 "What does the RC20 room controller regulate?", page 23):

- If the RC20 room controller is the only programming unit in the system, DHW heating commences automatically 30 minutes before the heating program starts its day mode. DHW is not produced during night mode. In day mode, the DHW circulation pump is started twice every hour for three minutes to ensure a constant supply of hot water to taps. The DHW temperature can be set to a maximum of 60 °C (= factory setting).
- If the RC20 room controller is installed as a remote control unit for one heating circuit <sup>1)</sup>, DHW heating and the operation of the DHW circulation pump for the entire heating system is adjusted using the programming unit (e.g. RC30/RC35). The selected DHW temperature can be modified using the RC30/RC35 or the RC20; however, the setting range of the RC30/RC35 applies (max. 80 °C).

#### 4.3.1 Setting the DHW temperature



**WARNING!**

#### RISK OF SCALDING

The factory-set DHW temperature is 60 °C. There is a risk of scalding at the taps if the temperature is set to above 60 °C.

- If the DHW temperature is set to above 60 °C, you should only draw off mixed hot and cold water.

You can check or change the DHW temperature:

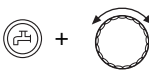

Hold the DHW key down and select the required DHW temperature using the rotary selector.

<sup>1)</sup> Not possible for operation using boilers with UBA 1.x.



Release the "DHW" key. The new DHW temperature setting is saved immediately. Then the standard display is shown again.

### 4.3.2 Single charge – domestic hot water <sup>1)</sup>

In day mode, DHW is recharged subject to demand if the DHW temperature falls 5 °C below the set value.

In night mode, any hot water can still be drawn from the DHW cylinder. The DHW temperature will have fallen below the set value if the green LED on the "DHW" key is illuminated. Should you require DHW at the selected DHW temperature once, proceed as follows:



Press "DHW".

The LED of the "DHW" key illuminates, and the "Single DHW charging" commences (up to the selected temperature).

Depending on the size of the DHW cylinder and the boiler rating, the DHW will be available after approx. 10 to 30 minutes. With instantaneous water heaters or combination boilers, DHW is available almost immediately.



#### USER NOTE

If you have started this function in error, press "DHW" again. Recharging will then be terminated and the LED stops flashing.



#### USER NOTE

In a modern Buderus DHW cylinder, the water only cools down at a rate of around 0.5 °C per hour when not being drawn, i.e. recharging only occurs after 10 hours. If necessary you can manually recharge the DHW to 60 °C (see section 4.3.2 "Single charge – domestic hot water <sup>1)</sup>", page 18).

<sup>1)</sup> Not possible for operation using boilers with UBA 1.x.

## 4.4 Setting day and time

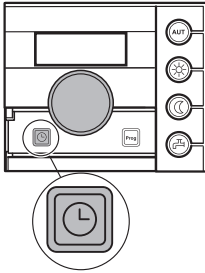

In order to function correctly, the correct day and time must be set on your heating system. Both can be selected on the room controller, for example after an extended power failure.

Day and time can only be selected on the RC30/RC35 if the RC20 room controller is allocated to a RC30/RC35 as remote control unit. The RC30/RC35 then assumes the setting on the RC20.

- Open flap.

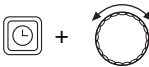

Hold down "Time" and select the current time using the rotary selector.

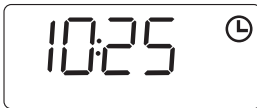

Release the "Time" key to store the time.



Hold down "Time" again, and select the current day using the rotary selector (1 = Mo, 2 = Tu,... 7 = Su).

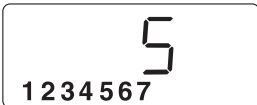

Release the "Time" key to store the day.



### USER NOTE

Even after a power failure, the clock continues to run for approx. 10 hours, as long as the room controller was supplied with power for at least six hours before the failure.

If the clock constantly loses or gains time, ask your heating contractor to make the necessary adjustments.

### 4.5 What is a heating program?

A heating program controls the automatic changeover of operating modes (day and night mode) at fixed times. The heating program also determines the times for DHW heating and the operation of the circulation pump.

Before you select a heating program, consider the following:

- At what time in the morning do you want your home to be warm? Does this time also depend on the day of the week?
- From what time in the evenings do you no longer need heating? This too may depend on the day of the week.

The RC20 room controller from Buderus offers eight preset standard programs that can be selected straightaway.

If the room controller has been installed as a remote control unit for an RC30/RC35 programming unit, heating programs from the RC30/RC35 can be used in the RC20 ("Own program", see section 4.7 "Heating program summary", page 22).



#### **USER NOTE**

The time taken for your heating system to heat up individual rooms may vary. This will be subject to the outside temperature, the building insulation and the drop in room temperature.

## 4.6 Heating program selection

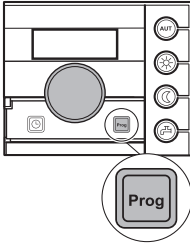

The RC20 room controller has eight different heating programs. See the following page for a summary of the preset times of these heating programs.

Please check which heating program best meets your requirements to optimise heat comfort and energy efficiency. Primarily check the number and times of the switching points for day and night mode. The "Pr 1" (family program) is factory-set.

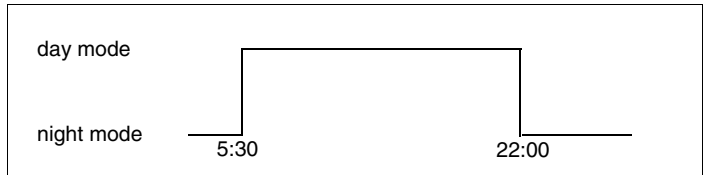
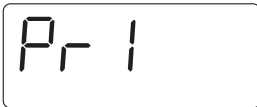
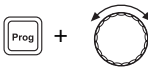

Fig. 4 Heating program "Pr 1" (factory setting) for Monday to Thursday

- Open flap.

Press and hold down the "Prog" key.



The number of the currently selected heating program is displayed (see Tab. 2). Select the desired heating program using the rotary selector.

Release the "Prog" key. The selected heating program has now been saved. Then the standard display is shown again.



### USER NOTE

The selected heating program is only effective if automatic mode is set (see section 4.1.2 "Selecting automatic mode", page 11).

## 4.7 Heating program summary

No.	Program	Day	ON	OFF	ON	OFF	ON	OFF
"Pr 1"	"Family" (factory setting)	Mo–Th Fr Sa Su	5:30 5:30 6:30 7:00	22:00 23:00 23:30 22:00				
"Pr 2"	"Morning" Early shift work	Mo–Th Fr Sa Su	4:30 4:30 6:30 7:00	22:00 23:00 23:30 22:00				
"Pr 3"	"Evening" Late shift work	Mo–Fr Sa Su	6:30 6:30 7:00	23:00 23:30 23:00				
"Pr 4"	"a.m." Part-time work in the morning	Mo–Th Fr Sa Su	5:30 5:30 6:30 7:00	8:30 8:30 23:30 22:00	12:00 12:00	22:00 23:00		
"Pr 5"	"Afternoon" Part-time work in the afternoon	Mo–Th Fr Sa Su	6:00 6:00 6:30 7:00	11:30 11:30 23:30 22:00	16:00 15:00	22:00 23:00		
"Pr 6"	"Midday" Midday at home	Mo–Th Fr Sa Su	6:00 6:00 6:00 7:00	8:00 8:00 23:00 22:00	11:30 11:30	13:00 23:00	17:00	22:00
"Pr 7"	"Single"	Mo–Th Fr Sa Su	6:00 6:00 7:00 8:00	8:00 8:00 23:30 22:00	16:00 15:00	22:00 23:00		
"Pr 8"	"Seniors"	Mo–Su	5:30	22:00				
"Pr 9"	"New"	Constant heating mode (24 hours). This is displayed on the RC20 while a new heating program is being entered in the RC30/RC35 (only if the RC20 is used as remote control). <sup>1)</sup>						
"Pr 0"	"Own program from RC30/ RC35"	Only when RC20 is used for remote control: activates "Own program 1" that has been specified for the RC20 heating circuit in the RC30/RC35. <sup>1)</sup>						
"Pr 10"	"Own program from RC35"	Only when RC20 is used for remote control in conjunction with RC35: activates "Own program 2" that has been specified for the RC20 heating circuit in the RC35. <sup>1)</sup>						

Tab. 2 Heating programs ("On" = day mode, "Off" = night mode)

<sup>1)</sup> Not possible for operation using boilers with UBA 1.x.

## 5 Information on setting the programming unit

### 5.1 What does the RC20 room controller regulate?

The RC20 room controller regulates the room temperature using the flow temperature of a heating circuit. The room controller can be tied into the Energy Management System (EMS) by two different methods:

- As sole programming unit for the system (factory setting):  
The RC20 room controller is fitted in a room (reference room) and is operated without another programming unit (for example RC30/RC35) being installed in the heating system.  
Example: detached house with one heating circuit.
- As remote control for one heating circuit: <sup>1)</sup>  
The RC20 room controller is operated in conjunction with a higher-level programming unit (for example RC30/RC35). The RC30/RC35 is installed either in a room or on the boiler, and regulates one heating circuit (e.g. the one in the living accommodation). The RC20 records the room temperature in the rented flat and regulates this second heating circuit. Basic heating system settings are regulated by the RC30/RC35, which are also made available to the RC20 heating circuit.  
Examples: semi-detached or detached house with two heating circuits (e.g. radiators and underfloor heating system).

<sup>1)</sup> Not possible for operation using boilers with UBA 1.x.

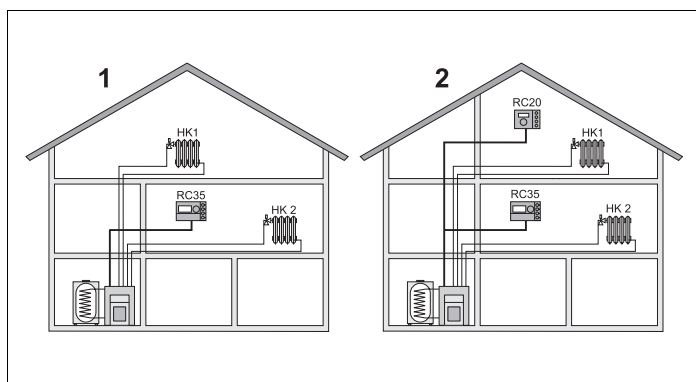

Fig. 5 Options for heating systems with two heating circuits

- Item 1:** Both heating circuits are controlled by one programming unit
- Item 2:** Each heating circuit has its own programming unit/remote control unit

## 5.2 Control modes for the heating control unit

The heating control unit can operate in three control modes. Your heating contractor will select and set up one of these options according to your requirements:

- Room temperature control: in this case, the programming unit must be installed in a room that is representative for the house. The programming unit measures the temperature in this "reference room". The flow temperature depends on the set and actual room temperature. This means that outside temperature influences in the reference room (e.g. an open window, sunlight or heat from a fireplace) will affect the rest of the house. Adjust the room temperature of the house or the reference room on the programming unit. To raise or lower the temperature in other rooms, adjust the thermostatic radiator valves.



- Outside temperature control (weather conditions):  
The outside temperature is measured by a temperature sensor. The level of the flow temperature is calculated exclusively from the outside temperature using the set heating curve.  
The room temperature for the entire house can be set in the programming unit (this causes the heating curve to move up or down). The thermostatic radiator valves must be adjusted in each room to a setting that will produce the required room temperature.
- Outside temperature control influenced by the room temperature: with this type of control, the flow temperature depends primarily on the outside temperature, but it is also determined by the room temperature within limits set by your heating contractor.



#### USER NOTE

If the RC20 has been installed as the only programming unit, room temperature control is always used.

If the RC20 has been installed as a remote control unit for a heating circuit, the type of control that has been set for the higher level programming unit (RC30/RC35) applies.

### 5.3 Tips on energy-efficient heating



- You can save 6 % on your heating bills by reducing the daytime temperature by 1 °C.
- Only run the heating if you need warmth. Use the switching program for automatic night setback.
- Ventilate rooms correctly: open the window wide for a few minutes rather than leaving it constantly open with a small gap.
- Close the thermostatic radiator valves when the room is being ventilated.
- Ensure that doors and windows are correctly sealed.
- Never stand large objects, such as a sofa, immediately in front of radiators (maintain a clearance of at least 50 cm). Otherwise the heated air cannot circulate and heat the room adequately.
- You can also save energy when heating DHW: compare the times at which rooms need to be heated with those at which you need hot water. If necessary, use a separate switching program for heating DHW.
- Arrange with your local heating contractor to have your heating system serviced annually.

## 6 Troubleshooting

This chapter details frequently asked questions about your heating system and their respective answers. This will, in many cases, enable you to troubleshoot perceived faults. Following these, faults and their remedies are listed in tabular form.

### 6.1 Frequently asked questions

***Why does the room temperature measured with a separate thermometer not correlate with the set room temperature?***

Different values influence the room temperature. The cold wall temperature will influence the RC20, if it has been fitted to a cold wall. If it is installed in a warm part of the room, e.g. close to a chimney, it will be influenced by the heat from that. Therefore, a separate thermometer can indicate a different room temperature than was set at the RC20 room controller.

To compare the actual room temperature with the values measured by another thermometer, the following are important:

- The separate thermometer and the RC20 room controller must be physically close to each other.
- The separate thermometer must be accurate.
- Never measure the comparative room temperature during the heat-up phase of the heating system; the RC20 room controller and the separate thermometer may react at different speeds to the rising room temperature.

If you have observed these points, and you still notice a deviation, your heating contractor can calibrate the room temperature displayed by the RC20.



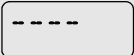
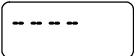
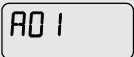

## 6.2 Fault displays

Service and fault messages can be viewed in the RC20 room controller display.

Tab. 3 details possible faults and special display messages.

Code	Display	Cause	Remedy
	No display: 	Your heating system has been switched OFF.	Switch your heating system ON.
		The power supply from the heating system to the RC20 has been interrupted.	Check whether the room controller sits correctly in its wall mounting base.
			Check whether two leads are connected to the room controller wall mounting base.
	After switching ON:  In addition, the key LEDs flash alternately.	Connection setup and initialisation: After start-up, data are transferred between the EMS and RC20 (no fault).	Wait a few seconds (up to one minute).
	When changing a setting: 	This parameter cannot be modified or this setting is not permissible.	
xxx/ xxx <sup>1)</sup>	Example:  The key LEDs flash alternately. The display does not flash.	The heating system or the RC20 has developed a fault. The cause of the fault may be temporary. The heating system automatically returns into standard mode.	Notify your heating contractor, if the permanent display does not automatically return.
	In addition the display flashes.	The heating system or the RC20 has developed a fault. Reset any flashing fault display by pressing "Reset".	Try and reset the fault (see Chapter 6.3 "Resetting faults (reset)", page 30).

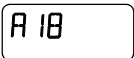
Tab. 3 Faults and special messages

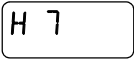
Code	Display	Cause	Remedy
A01/ 816 <sup>1)</sup>		Communication to the Energy Management System (EMS) is faulty, e.g. through a loose contact or through electro-magnetic interference.	Check whether the programming unit sits correctly in its wall mounting base. Check whether two leads are connected to the programming unit wall mounting base.
A11/ 802 <sup>1)</sup>		The date or time is not set. This may have been caused by an extended power failure, for example.	Enter the date and time on the RC30/RC35 to enable all heating programs and additional functions to work correctly.
A11/ 803 <sup>1)</sup>			
A18/ 802 <sup>1)</sup>		The date or time is not set. This may have been caused by an extended power failure, for example.	Enter the date and time on the RC20 to enable all heating programs and additional functions to work correctly.
Hxx <sup>2)</sup>	Example: 	Maintenance is required. The heating system remains active as long as possible.	Notify your heating contractor who should carry out the maintenance.
H 7 <sup>2)</sup>		The water pressure in the heating system has dropped to a low value. This is the only maintenance message which you can action yourself. The heating system must be equipped with a digital pressure sensor. Regularly check the heating system water pressure at the pressure gauge, if this is not installed.	Top up the heating water as described in the boiler operating instructions.

Tab. 3 Faults and special messages

- 1) The fault code has two digits. The first indicates the service code (e. g. "A01"). Turn the rotary selector clockwise to display the second part (e.g. "816").
- 2) Not possible for operation using boilers with UBA 1.x.



### USER NOTE

Further fault displays are feasible. For related explanations, see the documentation supplied or ask your local heating contractor.

Faults can be displayed as plain text on a programming unit, if your heating system has been equipped with such a unit (e.g. RC30/RC35).

### 6.3 Resetting faults (reset)

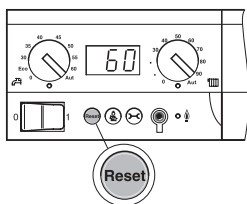

Some faults can be rectified by resetting the system. This applies to disabling faults. These can be recognised by the fact that the display on the BC10 boiler control unit or the UBA1.x will be flashing.

- Press the "Reset" button on the BC10 boiler control unit or the UBA1.x to reset the fault.

The display shows "rE" whilst the reset is implemented.

- Contact your heating contractor if pressing the button fails to reset the fault (display still flashing).



**CAUTION!**

#### **SYSTEM DAMAGE**

through frost.

The heating system can freeze up in cold weather if it has been switched OFF through a fault shutdown.

- Try and reset the fault.
- If this is impossible, immediately notify your heating contractor.

## 7 Index

<b>A</b>	
Automatic mode . . . . .	11
<b>C</b>	
Calibration, room temperature . . . . .	27
Cleaning . . . . .	5
Control mode . . . . .	24
<b>D</b>	
Day mode . . . . .	8, 11, 12
DHW circulation . . . . .	17
DHW temperature . . . . .	17
Display . . . . .	7
<b>E</b>	
Emergency stop switch – heating system . . . . .	4
Energy, saving . . . . .	26
Energy-efficient heating . . . . .	26
<b>F</b>	
Fault table . . . . .	28
Flap, key cover . . . . .	6, 8
Frost risk . . . . .	5, 30
<b>H</b>	
Heating mode normal, see Day mode setback, see Night mode Heating program . . . . .	20, 21
<b>I</b>	
In-between seasons, heating in . . . . .	12
<b>L</b>	
LED . . . . .	8
<b>M</b>	
Manual mode . . . . .	13
<b>N</b>	
Night mode . . . . .	8, 11, 12
<b>O</b>	
Operating mode . . . . .	11
automatic . . . . .	11
day . . . . .	13
manual . . . . .	13
night . . . . .	13
selection . . . . .	11
Operating status (symbols) . . . . .	8
Outside temperature control . . . . .	25
<b>P</b>	
Parameters, reset all . . . . .	30
Power failure . . . . .	19
Programming unit, sole . . . . .	23
<b>R</b>	
RC20 as remote control . . . . .	23
RC20, only one in the system . . . . .	23
Recharging DHW . . . . .	18
Reference room . . . . .	24
Remote control . . . . .	23
Reset . . . . .	30
Room temperature control . . . . .	24
Rotary selector . . . . .	6
<b>S</b>	
Safety . . . . .	4
Setting the room temperature . . . . .	14
Standard display . . . . .	7
Switching point . . . . .	11
<b>T</b>	
Temporary room setting . . . . .	15
Thermometer, separate . . . . .	27
Thermostatic valve . . . . .	11
Time, setting the . . . . .	19
<b>U</b>	
UBA1.x . . . . .	4
<b>W</b>	
Weather conditions . . . . .	25
Weekday . . . . .	19

Your installer:

# **Buderus**

Buderus  
Cotswold Way, Warndon, Worcester WR4 9SW  
Tel.: 01905 752794, Fax: 01905 753130  
[www.buderus-commercial.co.uk](http://www.buderus-commercial.co.uk)

BBT Thermotechnik GmbH  
D-35573 Wetzlar  
[www.heiztechnik.buderus.de](http://www.heiztechnik.buderus.de)  
[info@heiztechnik.buderus.de](mailto:info@heiztechnik.buderus.de)

In the UK, Buderus is a trading name of  
BBT Thermotechnology Ltd.